



P/N:AST-SWP08M-60HXYZA1-abcd

Note:

AST=Company Name;

SWP08=Product series,LED Wall Pack;

M=Product size,M=medium;

60=Rating Power;

H=dirver manufacturer,H=HBE;

X=LED manufacturer,B=lumileds;

Y=Cover type,SP=stripe PC;

Z=LED module type, S=single CCT;

A=Input voltage, 120-277VAC;

1=Version number;

“a” can be any two letters to represent lamp colors;

“b” can be “S” or blank for Surge-Protective Device provided or not;

“c” can be “W” or blank for dimming module provided or not;

“d” can be any digits for CCT;

DIMENSIONS

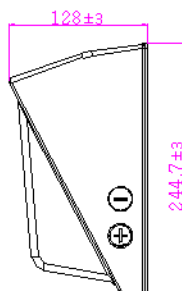
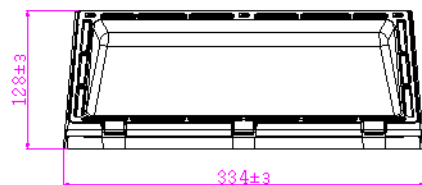
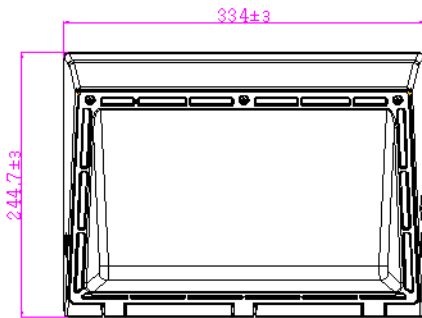

ADVANTAGE

- UL, cUL, certificate
- Lumileds 2835, high CRI.
- Input voltage 120-277VAC .
- Output constant current lever can be adjusted through output cable with 0-10V.
- No UV or IR in the beam.
- Wattage abjustable.
- Easy to install and operate.
- Energy saving, long lifespan.
- Light is soft and uniform, safe to eyes.
- Instant start, NO flickering, NO humming.
- Green and eco-friendly without mercury.

APPLICATION

- Entrance lighting,courtyard lighting;
- Industrial lighting,Outdoor landscape lighting;
- Building,The hotel;
- Wall lighting area and so on.

SPECIFICATIONS

OPTICAL	Input Power (Tolerance : ±10%)	60W	
	Color Temperature	2700-3500K	4000-6500K
	Lumen (Tolerance : -10%)	7200-7500LM/W	7800-8160LM
	Efficacy (Tolerance : -3%)	120-125LM/W	130-136LM/W
	CRI	>80	
	Color Consistency	<6 Steps (or <6 SDCM)	
	BUG	B2-U2-G2	
	Diffuser Type	PC	
	Beam Angle (50%) (Tolerance : ±15%)	104 Degree	
ELECTRICAL	Input Voltage and Frequency	120-277VAC 50/60Hz	
	PF (Tolerance : -3%)	≥0.9	
	THD (Tolerance : +5%)	≤20%	
	Flicker Percent	<30%	
	Driver Brand	HBE	
	Driver Model	HB-LPG060G-52	
	Driver Surge protection	L-N: 4kV , L&N-E: 4kV	
	Dimming	0-10V dimming standard	
	Sensor Type	No Sensor	
	Optional Accessory	Surge-protective Device, Photocell	
MATERIALS	LED Brand	LUMILEDS	
	LED Type	SMD 2835	
	LED QTY	176 PCS	
	Housing	Die-cast aluminum	
	Housing Color	All Color	
	Waterproof Rating	WET (IP65)	
OTHERS	Operating Temperature	-40°C TO 45°C	
	Storage Temperature	-40°C TO 80°C	
	Operating Humidity	20% - 90% RH	
	Storage Humidity	10% - 95% RH	
	Warranty	5 years warranty with 24/7 operating hours Luminaire lifetime at 25°C.	

PACKAGE

	Size	Qty / Carton	Net Weight / Carton	Gross Weight / Carton
Inner box	257*140*350MM	1 PCS	2.1KG	2.7KG
Outer box	300*277*374MM	2 PCS	4.2KG	5.9KG

Tolerance of Carton Size: ±15 MM, Tolerance of Weight: ±10%.

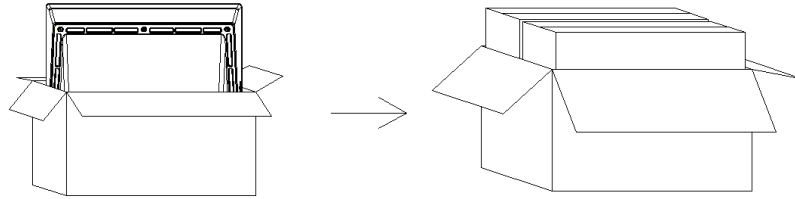

LIGHT DISTRIBUTION TESTING PARAMETERS

Test:U:120.08V I:0.5043A P:59.770W PF:0.9871 Freq:60.01Hz		
Lamp Flux:8093.59x1 lm		
NAME:	TYPE:	WEIGHT:
SPEC.:	DIM.:	SERIAL No.:
MFR.:	SUR.:	Shielding Angle:

DATA OF LAMP		PHOTOMETRIC DATA			
		Eff: 135.41 lm/W			
MODEL		I _{max} (cd)	3241	S/MH (C0/180)	1.21
NOMINAL POWER (W)	60	LOR (%)	100.0	S/MH (C90/270)	0.76
RATED VOLTAGE (V)	120	TOTAL FLUX (lm)	8093.6	η UP, DN (C0-180)	8.6, 69.8
NOMINAL FLUX (lm)	8093.59	CIE CLASS	DIRECT	η UP, DN (C180-360)	0.6, 21.0
LAMPS INSIDE	1	η up (%)	9.1	CIBSE SHR NOM	1.25
TEST VOLTAGE (V)	120	η down (%)	90.9	CIBSE SHR MAX	1.25

LUMINOUS INTENSITY DISTRIBUTION DIAGRAM

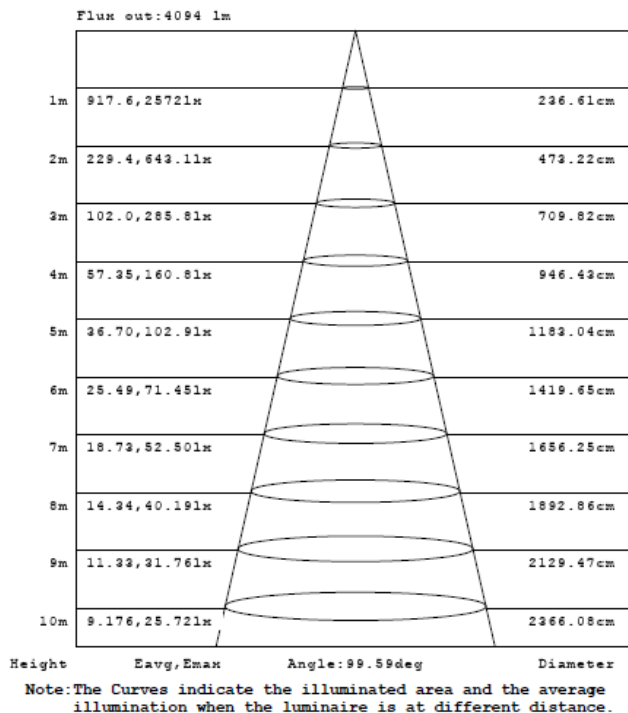
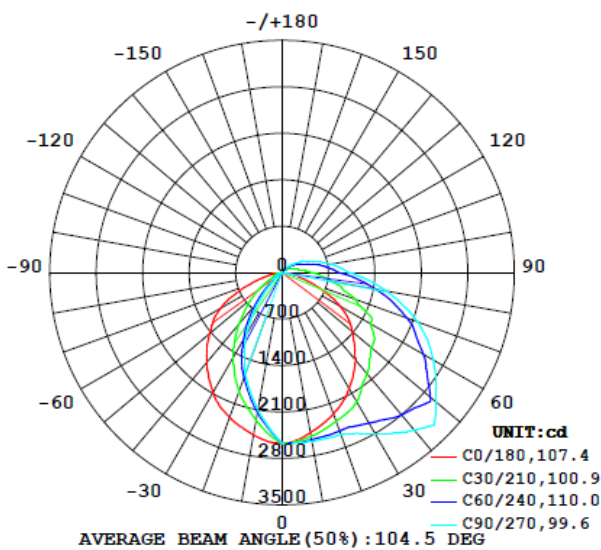

NOTICE FOR USER

- Please turn off power before install or change assembly parts.

- The input voltage and lamps should be matched, after connecting the power line, Please make sure the wiring section is insulated.
- No-professionals, must not install and disassemble the lamps.

TROUBLE SHOOTINGS

Troubles	Check points
Flickering of the light	Turn off the power and turn on again in 3 minutes. If same phenomena occur, then call agencies.
Out of working	Please check the connection.

SPECIAL FUNCTIONS INSTRUCTION:

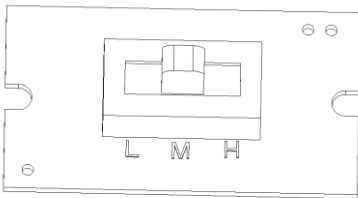

Wattage adjustable instruction

Turn the wattage adjustable knob to a certain wattage gear, the power of the lamp will change to the corresponding wattage.

Adjustable wattage range 25%-100%.

Note: Please turn off the power before adjusting the wattage.